

## Bacco

<b>Codice</b>	<b>3832-49-101</b>
<b>Tipologia</b>	Sospensione
<b>Designer</b>	S.T. Fabas Luce
<b>Codice a Barre</b>	8019282567677
<b>Tariffa doganale</b>	94051140
<b>Colore</b>	Nero
<b>Materiale</b>	Struttura in metallo e metacrilato
<b>IP</b>	IP20
<b>IK</b>	05
<b>Classe di Isolamento</b>	 CL2
<b>Dimensioni della Lampada</b>	MAX 2000mm Ø580mm - 1.4kg
<b>Dimensioni della Scatola</b>	80x625x625mm - 2.5kg
	<b>Sorgente luminosa 1</b>
<b>Sorgente</b>	LED Integrato
<b>Flusso Sorgente Luminosa</b>	6600 lm
<b>Flusso Apparecchio</b>	4950 lm
<b>Temperatura Colore</b>	CCT (2700K 3000K 4000K)
<b>Classe Energetica</b>	 F
	<b>Specifica elettrica 1</b>
<b>Tensione di Alimentazione</b>	230V AC 50Hz
<b>Potenza Totale Assorbita</b>	56W
<b>Sistema di Controllo</b>	Dimmerabile a taglio di fase

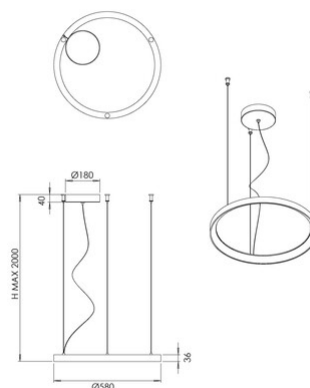

CE