



Bacco

Codice	3832-40-119
Tipologia	Sospensione
Designer	S.T. Fabas Luce
Codice a Barre	8019282566861
Tariffa doganale	94051140
Colore	Ottone satinato
Materiale	Struttura in metallo e metacrilato
IP	IP20
IK	05
Classe di Isolamento	 CL1
Dimensioni della Lampada	MAX 2000mm Ø580mm - 1.7kg
Dimensioni della Scatola	105x625x625mm - 3.1kg
	Sorgente luminosa 1
Sorgente	LED Integrato
Flusso Sorgente Luminosa	6600 lm
Flusso Apparecchio	4950 lm
Temperatura Colore	CCT (2700K 3000K 4000K)
Classe Energetica	
	Specifica elettrica 1
Tensione di Alimentazione	230V AC 50Hz
Potenza Totale Assorbita	56W
Sistema di Controllo	Dimmerabile a taglio di fase

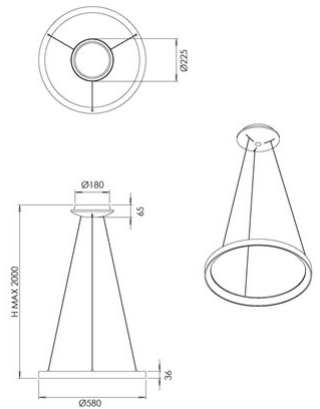

CE